

**Parallel gripper**

Three-jaw gripper

Angle gripper

Internal-hole gripper

Other grippers

Electric gripper

GP403 GP404 **GP406** GP408 GP410 GP412 GP416 GP420 GP430 Universal jaw

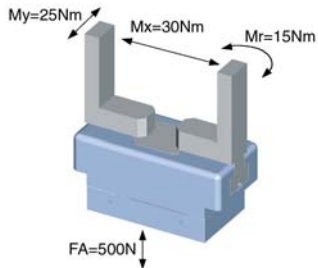
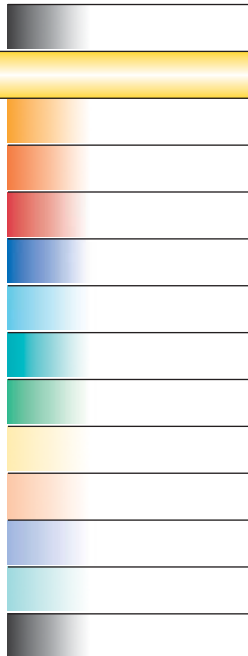

**Parallel gripper**  
with T-slot guide

Advantages, benefits, comparisons and tips!  
Stacks of information all about this product are  
on page 17.

Gripping force as a function of jaw length

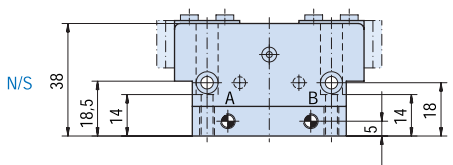
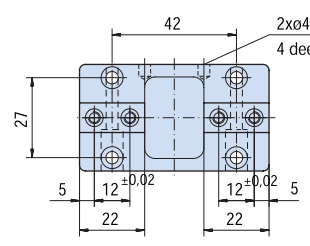
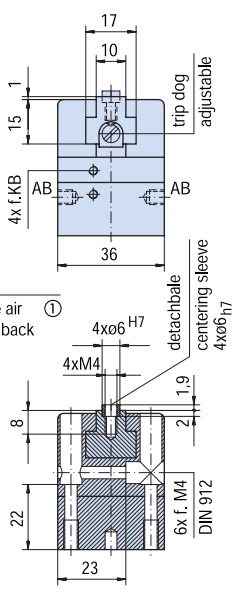
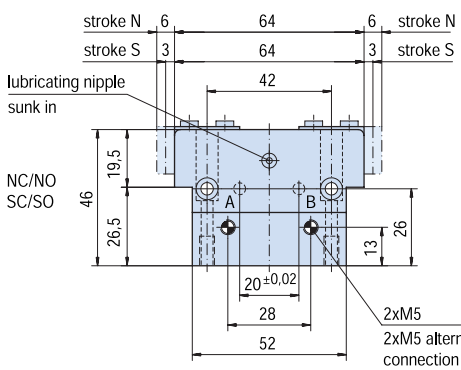
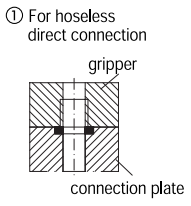
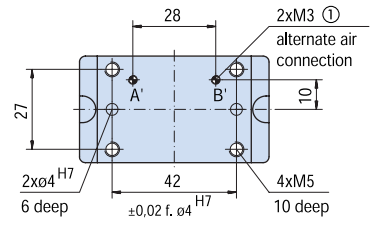
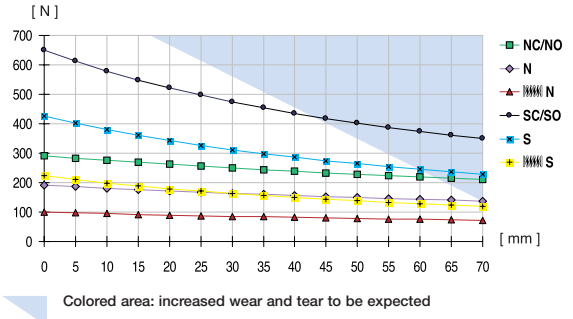

Order no.:					
GP406 N	GP406 NC	GP406 NO	GP406 S	GP406 SC	GP406 SO
Drive:					
pneum.	pneum.	pneum.	pneum.	pneum.	pneum.
Stroke per jaw [mm]:					
6	6	6	3	3	3
Gripping force in closing and opening [N]:					
190	-	-	420	-	-
Gripping force in closing [N]:					
-	290	-	-	650	-
Gripping force in opening [N]:					
-	-	290	-	-	650
Self-locking via:					
DSV1/8	Spring	Spring	DSV1/8	Spring	Spring
Closing time/opening time [s]:					
0,009	0,015	0,015	0,009	0,015	0,015
Repeatability ± [mm]:					
0,025	0,025	0,025	0,025	0,025	0,025
Min./max. operating pressure [bar]:					
3 / 8	5 / 8	5 / 8	3 / 8	5 / 8	5 / 8
Air volume per cycle [cm <sup>3</sup> ]:					
7	11	11	7	11	11
Min./max. operating temperature [°C]:					
5 / 80	5 / 80	5 / 80	5 / 80	5 / 80	5 / 80
Temp. resistant version up to 150° C [add to part number]:					
T2	T2	T2	T2	T2	T2
Piston diameter [mm]:					
25	25	25	25	25	25
Weight [kg]:					
0,27	0,32	0,32	0,27	0,32	0,32

All data measured at 6 bar.

See Page 17 for Accessory list.